

ANTENNAS | PUCK-5 SERIES

5-IN-1 TRANSPORTATION & IOT/M2M ANTENNA

617 – 4200 MHz, 2X2 LTE (MIMO); 2400 – 7200 MHz, 2X2 Wi-Fi (MIMO); GPS/GLONASS



| | | | | | |
|---|--|---|--|---|---|
|  617 – 960 MHz 1427 – 1517 MHz 1710 – 2700 MHz 3400 – 4200 MHz |  LTE: 6 dBi Wi-Fi: 7.5 dBi GPS: 21 dBi |  2.4 – 2.5 GHz 5.0 – 7.2 GHz |  Omni-Directional |  4G LTE |  5G |
|  Machine to Machine |  CBRS Band |  2X2 MIMO |  IP69K |  -40°C to +80°C |  GPS Included |

APPLICATION AREAS

-  Urban
-  Rural/Farm
-  Marine
-  Vehicle
-  Meter

- 5-in-1 LTE high performance multi frequency antenna
- 2G/3G/4G/LTE/5G antenna
- LTE (2X2 MIMO), Dual-band Wi-Fi (2X2 MIMO), GPS/GLONASS
- Wideband – covers wide frequency band, incl. 3.5 GHz CBRS band
- Robust, vandal resistant and waterproof (IP69K)
- Ideal for transportation, marine and IoT/M2M use
- Ultra-versatile mounting options for easy installation

Product Overview

Poynting's new PUCK antenna offers a small profile antenna for use in the IoT/M2M, Smart Meter, Smart Utilities, Transportation, Marine and the Agricultural/Farming markets. The PUCK-5 consists of a 5-in-1 antenna system within a single housing, featuring 2X2 MIMO LTE, 2X2 MIMO Wi-Fi (Dual-band 2.4 GHz & 5 GHz) and GPS/GLONASS. The 2x Cellular MIMO antennas (for 2G/3G/4G) cover the 617 MHz to 4200 MHz band, this includes the most popular international LTE bands. The antenna provides two separate dual-band Wi-Fi antennas offering concurrent 2.4GHz and 5 GHz bands, capable of 802.11n and 802.11ac/ax with 2x2 MIMO. The fifth antenna is a high-performance active GPS/GLONASS system operating at temperatures as low as -40°C. The PUCK exceeds the performance of many competitors due to the attention to design of this high-performance antenna. The radiation patterns of all radiating elements provide an excellent balance between omnidirectionality, pattern diversity and good radiation abilities at the desired elevation, which is often overlooked in such a small size antenna. Despite its small size, this antenna provides excellent performance especially at the higher frequency bands, where performance is critical for LTE throughput and connection stability. This antenna is designed so that both the LTE ports are connected to the router/device to ensure the best performance. Please see other derivatives of the PUCK range that are more suitable for a SISO application.

Features

- Small & Low-profile (Ø100mm x h 36mm)
- Careful mechanical design provides ruggedness, corrosion, water and dust resistance (IP69K)
- Fire Resistant
- UV Stable Enclosure
- 5G Ready – includes the 3.2 GHz to 3.8 GHz CBRS Band
- Easy installation; multi-implementation options available:
 - Spigot Mount
 - Magnetic Mount
 - Adhesive Tape Mount
 - Bracket Mount

Application Areas

- Smart utilities: Smart power, Gas & Water Metering
- Smart Buildings: Climate control, access control, security, irrigation
- Industrial factory automation, robotic machinery and other M2M systems
- Digital Signage
- Warehouses & Logistic systems
- Transport (Busses, Utility & Public Safety)
- Mining Vehicles & Machinery communications, telemetry and automation (M2M & IoT)
- Agricultural machinery
- Marine: small boats, yachts near to coastlines or inner waters



Frequency Bands

The PUCK-5 is an omni-directional antenna that works from 617 – 960 MHz | 1427 – 1517 MHz | 1710 – 2700 MHz | 3400 – 4200 MHz | and the following Wi-Fi frequency bands | 2400 – 2500 MHz | and | 5000 – 7200 MHz |

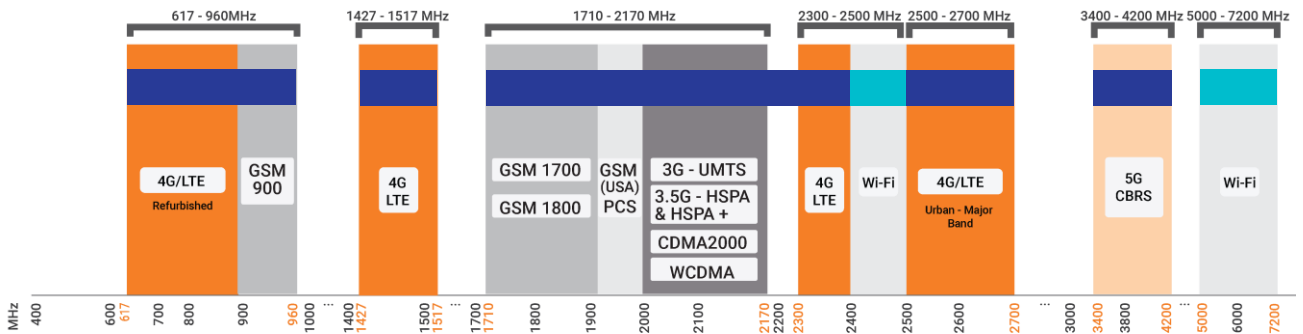

Indicates the LTE bands on which PUCK-5 works Indicates the WI-FI bands on which PUCK-5 works

Antenna Derivatives

| Product Order Code (SKU) | A-PUCK-0005-V1-01 | A-PUCK-0005-V1-01-W |
|--------------------------|-----------------------|---------------------|
| Radome Colour | Black | White |
| Radome Material | PC+ABS (Halogen free) | UV Stable ASA |
| Ports | 5 | 5 |
| SISO / MIMO | 2X2 MIMO | 2X2 MIMO |
| Coax Cable Type | RTK-031 | RTK-031 |
| Coax Cable Length | 2m | 2m |
| Connector Type | SMA (M) | SMA (M) |
| EAN | 6009880915170 | 6009710920817 |
| EU Homologation Number | E1*10R06/01*9551*00 | E1*10R06/01*9551*00 |

*The coax cable & connector are factory mounted to the antenna

Electrical Specifications - Cellular

| | |
|-----------------------------------|--|
| Frequency Bands: | 617 – 960 MHz 1427 – 1517 MHz 1710 – 2700 MHz 3400 – 4200 MHz |
| Gain (Max) Port 1 & 2: | 0 dBi @ 617-960 MHz 1 dBi @ 1427-1527 MHz 5 dBi @ 1710-2700 MHz 6 dBi @ 3400-4200 MHz |
| VSWR Port 1 & 2: | ≤2.5:1 Across 85% of the bands |
| Feed Power Handling: | 10 W |
| Input Impedance: | 50 Ohm (nominal) |
| Polarisation: | Linear Vertical |
| Coax Cable Loss: | 0.56 dB/m @ 900 MHz 0.785 dB/m @ 1800 MHz 1.2 dB/m @ 3000 MHz |
| DC Short: | Yes |

Electrical Specifications - GPS/Glonass Antenna

| | |
|-------------------------------------|--|
| Frequency Range (GPS): | 1575.42MHz/1600MHz |
| Gain (Max): | 21+/-2dBi |
| VSWR: | ≤1.5:1 |
| DC Voltage: | 2.7-3.3 V |
| DC Current: | 5-15mA |
| Noise Figure: | ≤1.5 dB |
| Nominal Impedance: | 50 Ω |
| Polarisation: | RHCP |
| Filter Out Band Attenuation: | 12dB Min f0+50MHz, 16dBi Min f0-50MHz |
| Voltage: | 2.7 - 3.3V |
| Max. Power-W: | 50 |
| Coax cable loss: | 0.71 dB/m @ 1500 MHz |

Electrical Specifications – Wi-Fi

| | |
|-----------------------------------|--|
| Frequency: | 2400-2500 MHz 5000–7200 MHz |
| Gain (Max) Port 1 & 2: | 5 dBi @ 2400-2500 MHz 7.5 dBi @ 5000–7200 MHz |
| VSWR Port 1 & 2: | ≤2:1 over 95% of the band |
| Feed power handling: | 10 W |
| Nominal input impedance: | 50 Ohm (nominal) |
| Polarisation: | Linear Vertical |
| Coax Cable Loss: | 0.91 dB/m @ 2400 MHz 1.65 dB/m @ 5800 MHz |
| Path to Ground: | Yes |

Product Box Contents

| | |
|--------------------------|--|
| Antenna: | A-PUCK-0005-V1-01 |
| Mounting Bracket: | Ø20 Threaded Spigots (Up to 60mm clamping thickness), Adhesive Surface Mounting & Magnetic Mount |
| Adapters: | 2x RP-SMA(m) To SMA (f) |

Mechanical Specifications

| | |
|-----------------------------|---|
| Product Dimensions | Ø99.3 mm x 36 mm |
| Packaged Dimensions: | 150 mm x 150mm x 120mm |
| Weight: | 0.523kg |
| Packaged Weight: | 0.654kg |
| Mounting Type: | Ø20 Threaded Spigot, Pole, Wall, Surface and Magnetic mount |

Environmental Specifications, Certification & Approvals

| | |
|---|-------------------------------------|
| Wind Survival: | ≤220 km/h |
| Temperature Range (Operating): | -40°C to +80°C |
| Environmental Conditions: | Outdoor/Indoor |
| Water Ingress Protection Ratio/Standard: | IP69K |
| Salt Spray: | MIL-STD 810G/ASTM B117 |
| Operating Relative Humidity: | Up to 98% |
| Storage Humidity: | 5% to 95% - non-condensing |
| Storage Temperature: | -40°C to +80°C |
| Enclosure Flammability Rating: | UL 94-HB |
| Impact Resistance: | IK 10 |
| Product Safety & Environmental: | Complies with CE and RoHS standards |



Antenna Performance Plots

VSWR: Cellular Antenna

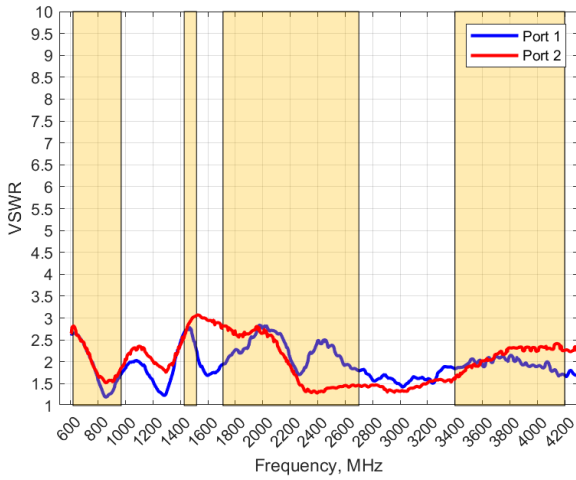

Voltage Standing Wave Ratio (VSWR)*

VSWR is a measure of how efficiently radio-frequency power is transmitted from a power source, through a transmission line, into a load. In an ideal system, 100% of the energy is transmitted which corresponds to a VSWR of 1:1.

The PUCK-5 delivers superior performance across all bands with a VSWR of $\leq 2.5:1$ across 85% of the bands.

**Measured with 2m low loss cable, 650 x 650 mm ground plane, and unused ports terminated with 50Ω load.*

VSWR: Wi-Fi Antenna

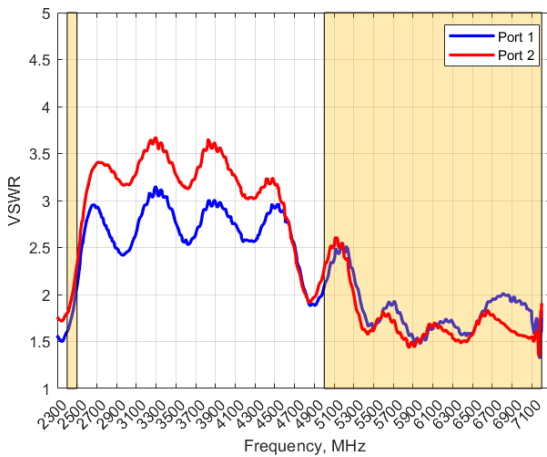

Voltage Standing Wave Ratio (VSWR)*

VSWR is a measure of how efficiently radio-frequency power is transmitted from a power source, through a transmission line, into a load. In an ideal system, 100% of the energy is transmitted which corresponds to a VSWR of 1:1.

The PUCK-5 delivers superior performance across all bands with a VSWR of $\leq 2:1$ across 95% of the bands.

**Measured with 2m low loss cable, 650 x 650 mm ground plane, and unused ports terminated with 50Ω load.*

GAIN (Excluding Cable Loss): Cellular Antenna

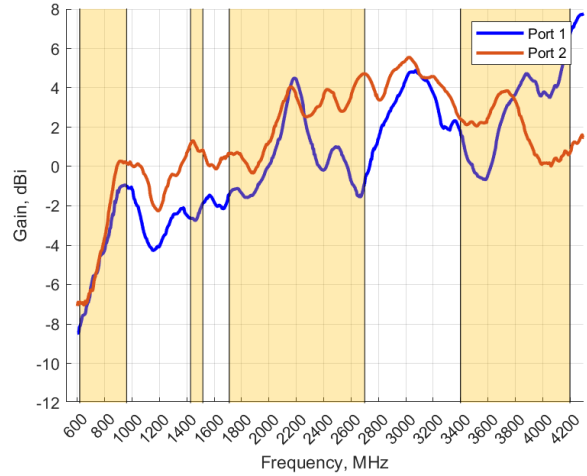

Gain* in dBi

6 dBi is the peak gain across all bands from 617 – 4200 MHz

| | |
|-------------------------|-------|
| Gain @ 617 – 960 MHz: | 0 dBi |
| Gain @ 1427 – 1517 MHz: | 1 dBi |
| Gain @ 1710 – 2700 MHz: | 5 dBi |
| Gain @ 3400 – 4200 MHz: | 6 dBi |

**Antenna gain measured with polarisation aligned standard antenna*

GAIN (Excluding Cable Loss): Wi-Fi Antenna

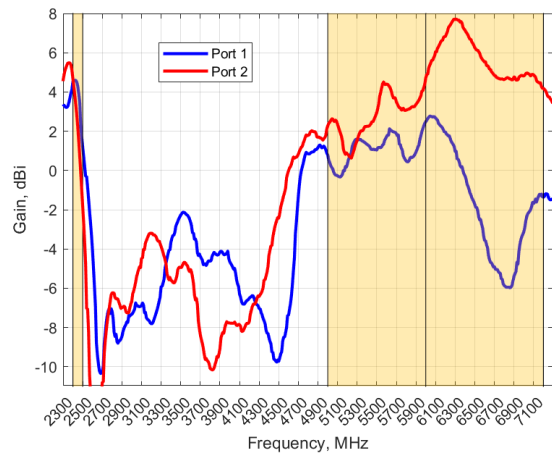

Gain* in dBi

7.5 dBi is the peak gain across all bands from 2400 – 2500 MHz & 5000 – 7200 MHz

| | |
|-------------------------|---------|
| Gain @ 2400 – 2500 MHz: | 5 dBi |
| Gain @ 5000 – 7200 MHz: | 7.5 dBi |

**Antenna gain measured with polarisation aligned standard antenna*

Technical Drawings

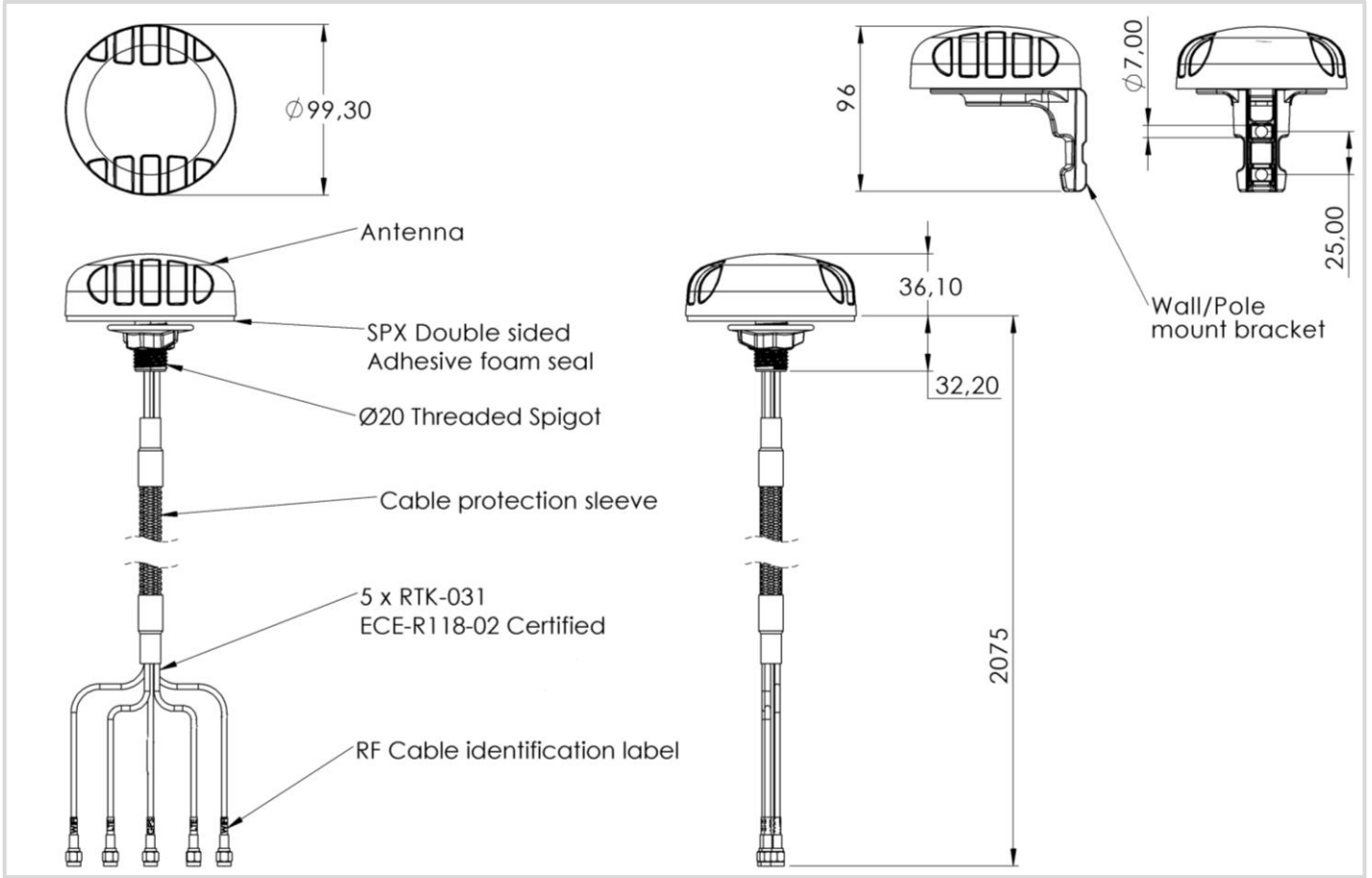

Radiation Patterns – Cellular

Azimuth: 617 – 968 MHz

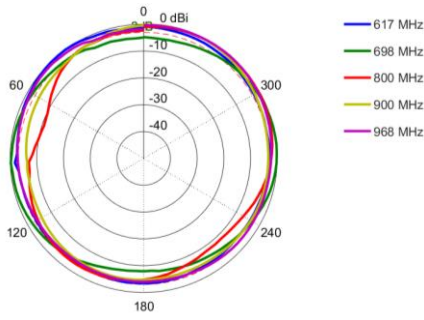

Azimuth: 1427 – 1517 MHz

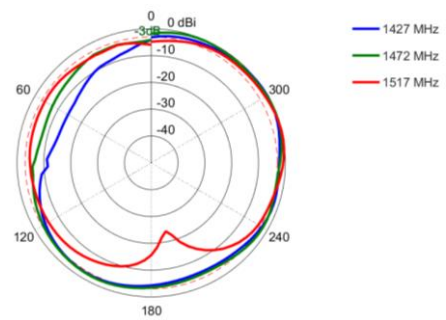

Azimuth: 1710 – 2170 MHz

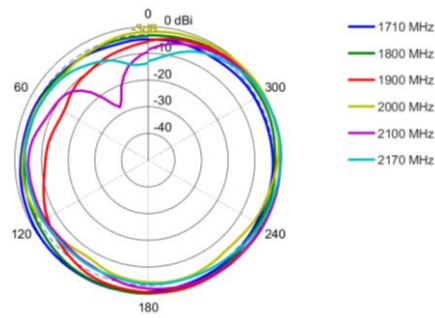

Azimuth: 2300 – 2700 MHz

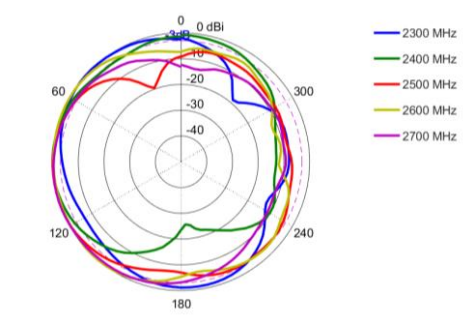

Azimuth: 3400 – 3800 MHz

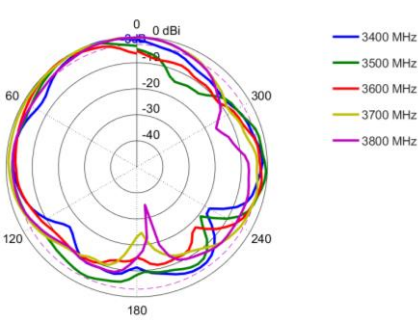

Azimuth: 4000 – 4200 MHz

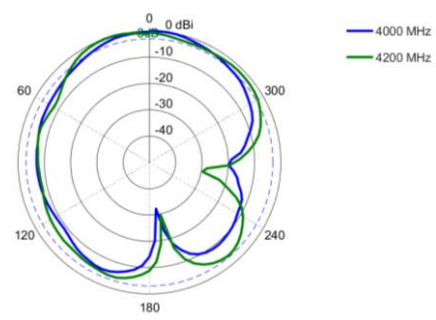

Elevation 1: 617 – 968 MHz

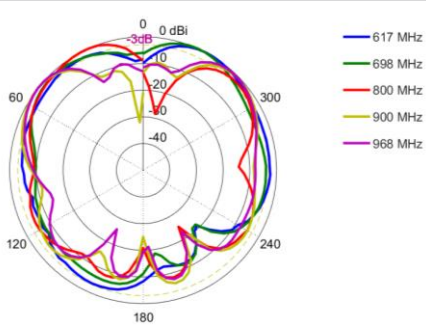

Elevation 1: 1427 – 1517 MHz

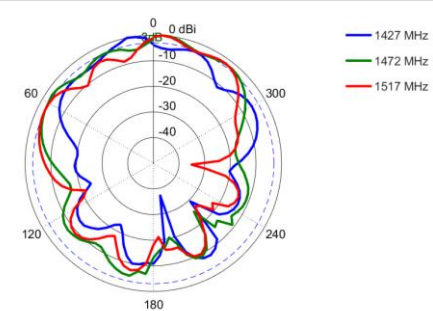

Elevation 1: 1710 – 2170 MHz

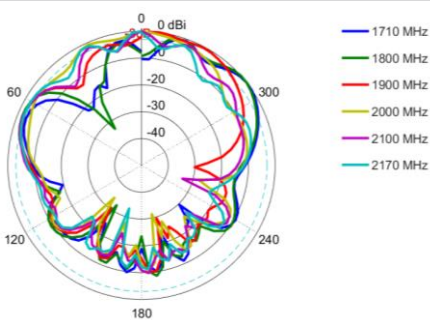

Elevation 1: 2300 – 2700 MHz

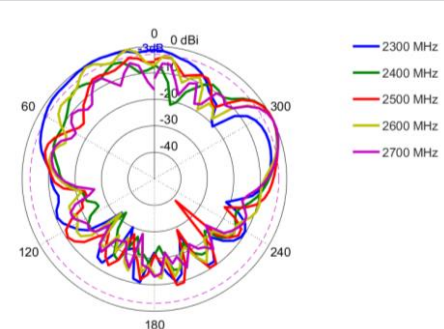

Elevation 1: 3400 – 3800 MHz

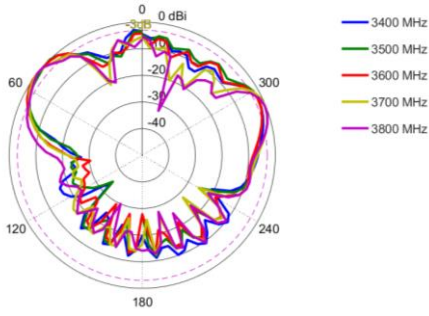

Elevation 1: 4000 – 4200 MHz

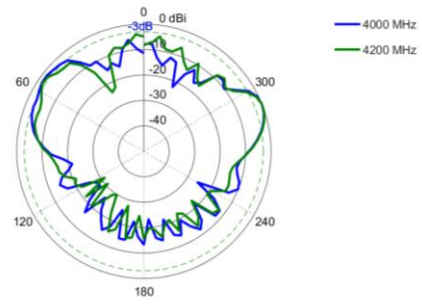

Elevation 2: 617 – 968 MHz

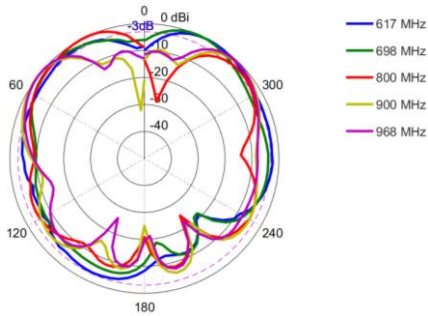

Elevation 2: 1427 – 1517 MHz

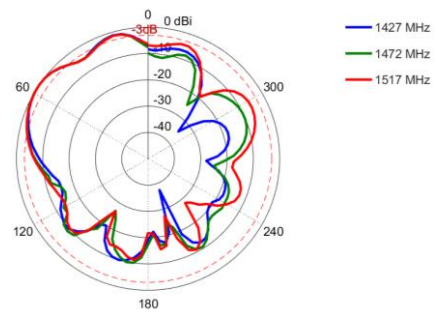

Elevation 2: 1710 – 2170 MHz

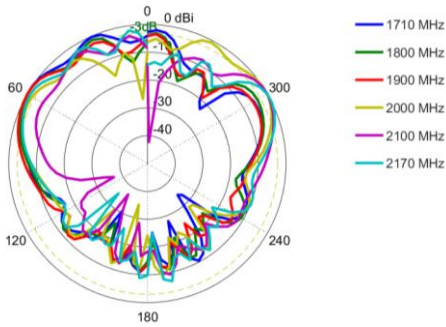

Elevation 2: 2300 – 2700 MHz

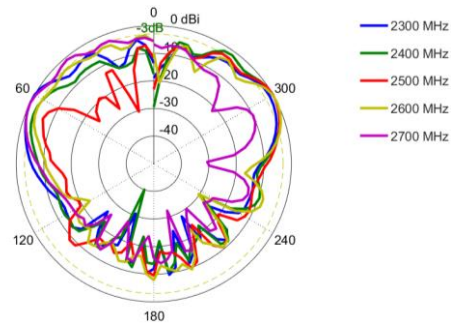

Elevation 2: 3400 – 3800 MHz

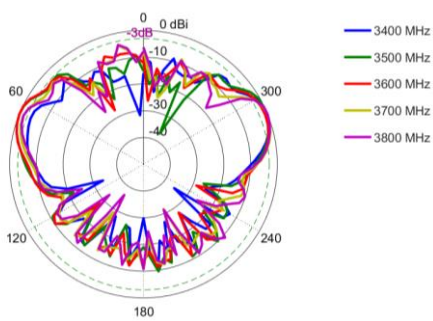

Elevation 2: 4000 – 4200 MHz

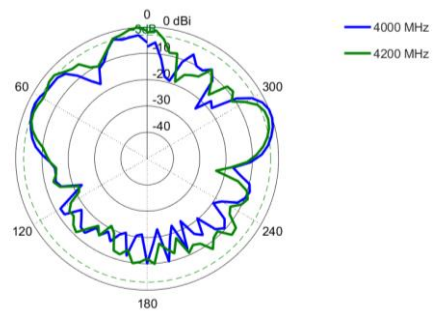

Radiation Patterns – Wi-Fi

Azimuth: 2400 – 2500 MHz

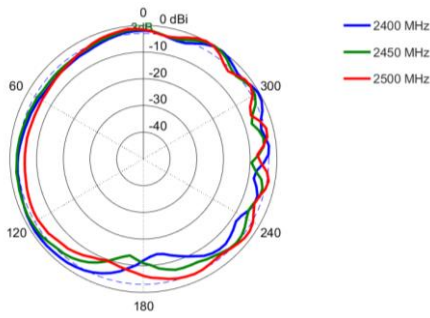

Azimuth: 5000 – 5400 MHz

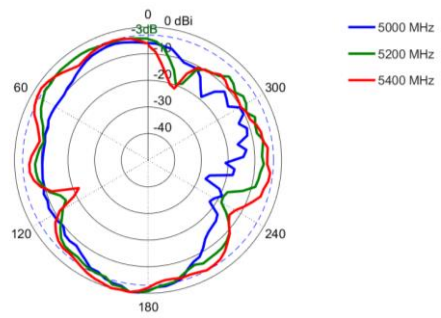

Azimuth: 5600 – 5800 MHz

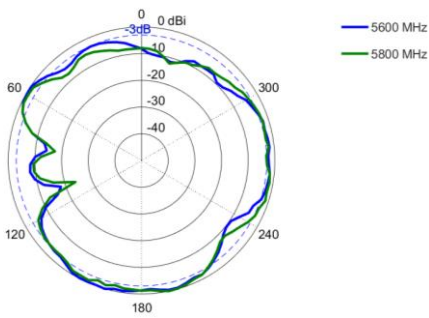

Azimuth: 6000 – 7200 MHz

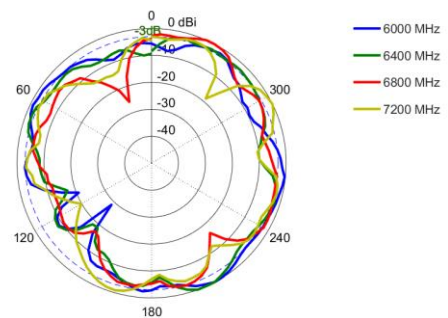

Elevation 1: 2400 – 2500 MHz

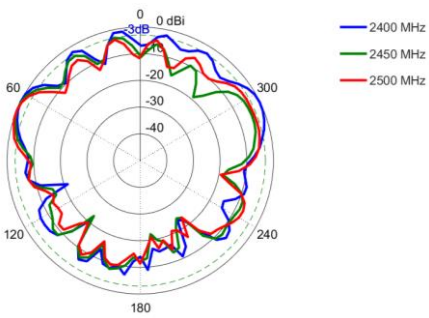

Elevation 1: 5000 – 5400 MHz

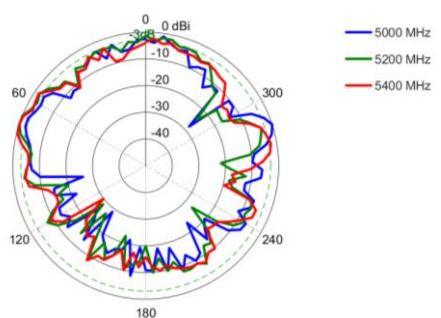

Elevation 1: 5600 – 5800 MHz

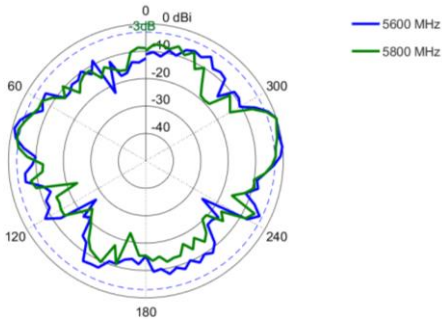

Elevation 1: 6000 – 7200 MHz

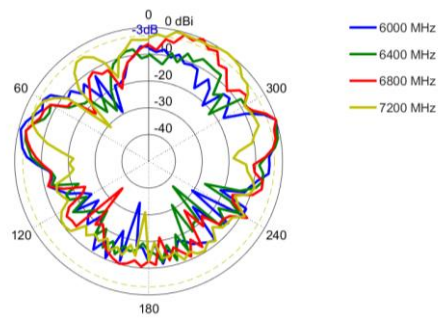

Elevation 2: 2400 – 2500 MHz

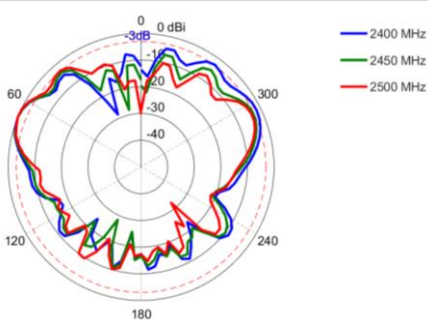

Elevation 2: 5000 – 5400 MHz

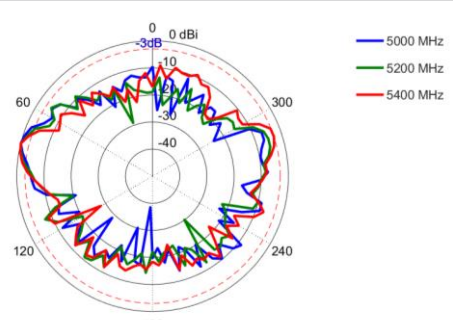

Elevation 2: 5600 – 5800 MHz

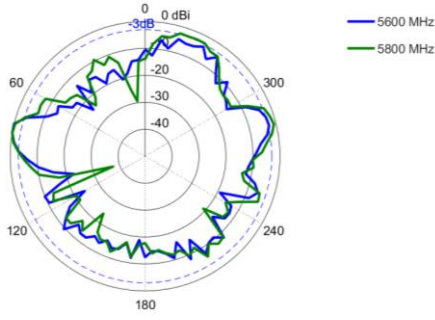

Elevation 2: 6000 – 7200 MHz

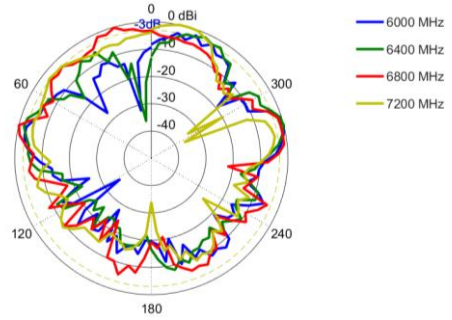

Radiation Patterns – GPS

XY Plane: 1561–1602 MHz

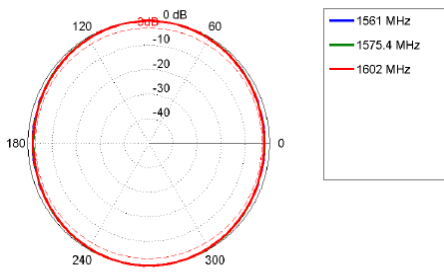

XZ Plane: 1561–1602 MHz

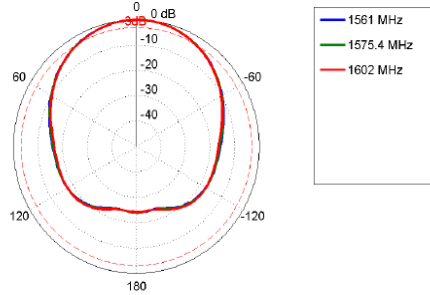

YZ Plane: 1561–1602 MHz

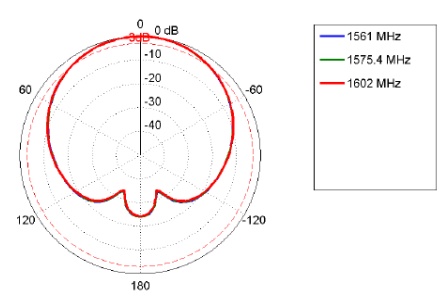

Mounting Options

Many Mounting Possibilities – included as standard

Poynting's new PUCK antenna range provides easy installation with the multiple mounting options. This includes as standard:

- Spigot Mount - two different lengths included (35mm & 75mm)
- Vertical Pole mount (inner & outer mounting for smaller and larger poles)
- Horizontal Pole Mount (e.g., marine rails)
- Magnetic Mount
- Surface Mount (Double Sided Tape)
- Wall Mount

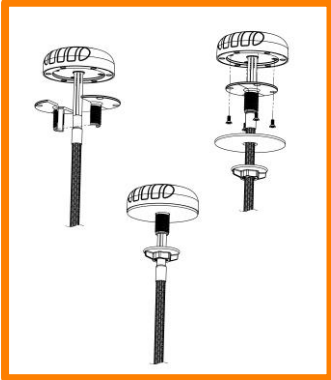

Spigot Mount

Removable 35mm & 75mm threaded spigot (included)

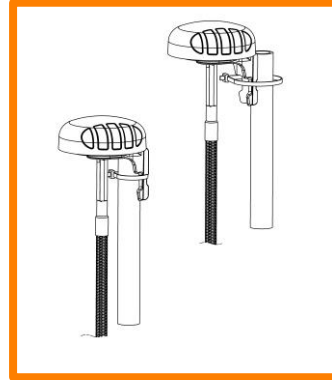

Vertical Pole Mount

Pole/Wall Mounting bracket (included)

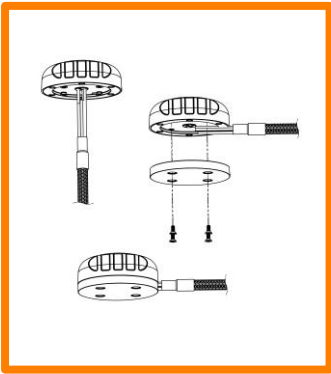

Magnetic Mount

Magnetic Base (included)
For temporary and low mobility installations.

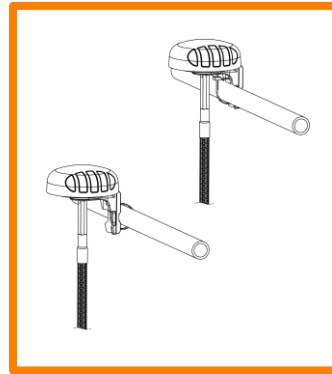

Horizontal Pole Mount

Pole/Wall Mounting bracket (included)

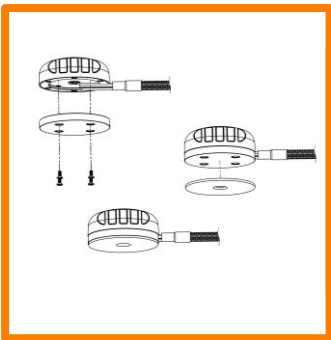

Surface Mount

Adhesive Surface Mounting (included) or can also be directly secured with longer M4 bolts (not included) to the female threaded inserts located in the antenna base

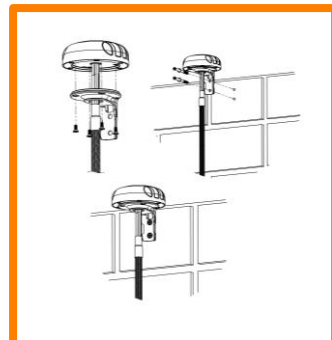

Wall Mount

Pole/Wall Mounting bracket (included)

Additional Accessories

See accessories technical specifications on www.poynting.tech



CONTACT POYNTING

Poynting Antennas (Pty) Ltd - Head Office

Unit 4, N1 Industrial Park,
Landmarks Avenue,
Samrand, 0157, South Africa

Phone: +27 (0) 12 657 0050

E-mail: info@poynting.tech

International Email: sales-global@poynting.tech

Poynting Europe

Regus Business Center Neue Messe Riem
Kronstadter Straße 4
81677 München
Germany

Phone: +49 89 7453 9002

E-mail: sales-europe@poynting.tech

Poynting USA

1804 Owen Court, Suite 104,
Mansfield,
TX 76063
USA

Phone: +1 817 533-8130

E-mail: sales-us@poynting.tech